

decōstyle



the
elegance &
solidity of
steel

metal wardrobe
shoecab
shoebench

EXPLORE

www.decostyle.co.in

decostyle



designer
customizable
world class

home
almirah

EXPLORE



safe
good design
convenient
metal almirahs
for home

DESIGNED & MADE by
decostyle



elegant
useful
easy to use
almirah

DESIGNED & MADE by
decostyle

compact
practical
secure
almirah



DESIGNED & MADE by
decostyle





compact
practical
secure
almirah



versatile
smart
made in india
almirah



ergonomic &
painstakingly
finished
almirah

DESIGNED & MADE by
decoSTYLE

global design
indian heart
world class
almirah



DESIGNED & MADE by
decostyle

ergonomic &
painstakingly
finished
almirah



DESIGNED & MADE by
decostyle

elegant
extra storage
smart
almirah



stylish
vibrant
long lasting
almirah



DESIGNED & MADE by
decostyle

expandable
customizable
elegant
almirah



expandable
spacious
designer
almirah



DESIGNED & MADE by
decoSTYLE



smart storage
efficient
for work
almirah



smart storage
sturdy
for kitchen
almirah



DESIGNED & MADE by
decostyle

CONFIGURE YOUR OWN

Step 2 Select Interior



CONFIGURE YOUR OWN

Step 3 Select Door Colour



H1
(Standard handle shipped
with all models)

Step 4 Select Designer Handles (Available in natural wood finish)

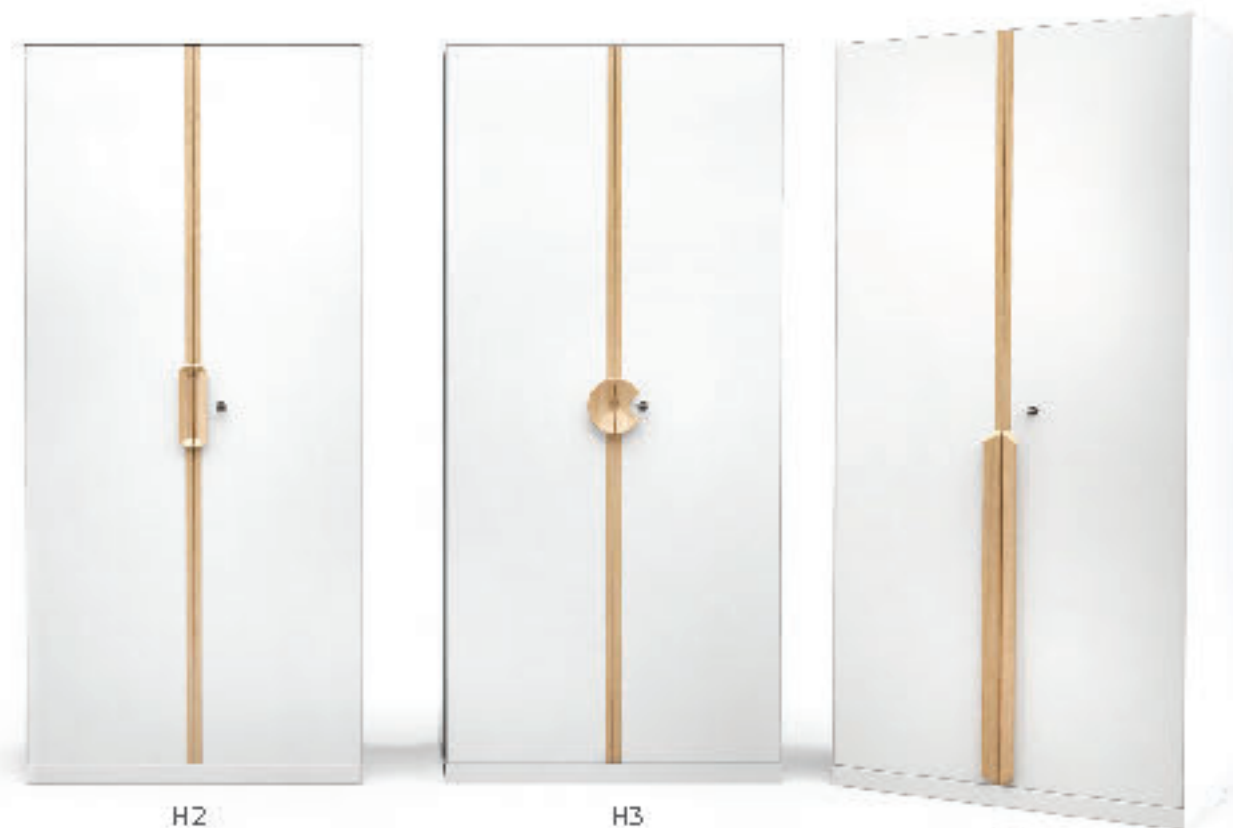

H2

H3

H4

CONFIGURE YOUR OWN

Step 5 Select Add On Accessory



Dimensions



SINGLE DOOR ALMIRAH
HEIGHT 197 cm
WIDTH 46 cm
DEPTH 56 cm



2 DOOR BASIC ALMIRAH
HEIGHT 197 cm
WIDTH 90 cm
DEPTH 56 cm

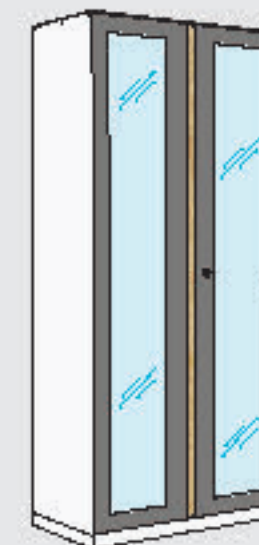

2 DOOR STORAGE ALMIRAH
HEIGHT 197 cm
WIDTH 90 cm
DEPTH 56 cm



SINGLE DOOR ALMIRAH
HEIGHT 248 cm
WIDTH 46 cm
DEPTH 56 cm

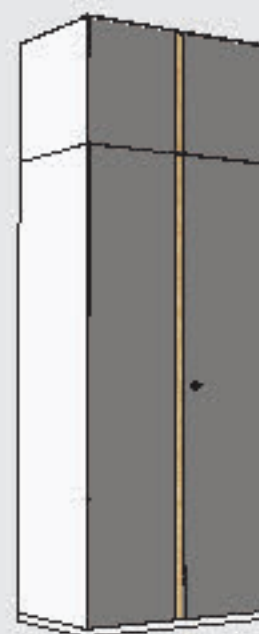

2 DOOR STORAGE ALMIRAH
with OVERHEAD UNIT
HEIGHT 248 cm
WIDTH 90 cm
DEPTH 56 cm



DRESSING UNIT
HEIGHT 197 cm
WIDTH 46 cm
DEPTH 56 cm

Safety & Strong Design

its safe!

Furniture with the strength of steel. Without giving up on precision finishes where every detail is treated delicately. To achieve this, we use cutting-edge technology.



strong design

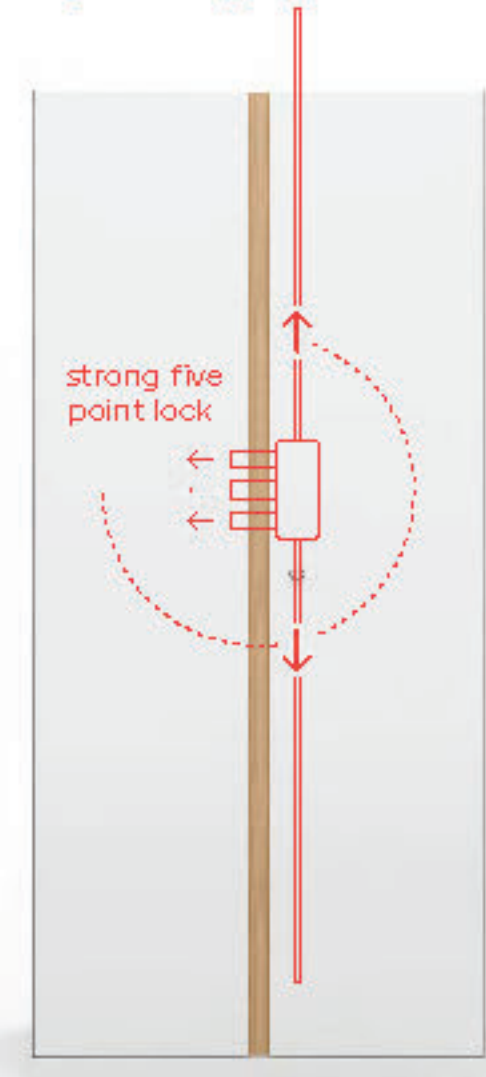

Functions & Features



high quality hettich hinges,
telescopic slides and wave keys



www.decostyle.co.in

decōstyle



safe
good design
convenient

chic
almirah

EXPLORE

safe
good design
convenient
chic almira

DESIGNED & MADE by
decostyle

AVAILABLE COLORS



FEATURES INCLUDED IN ALMIRAH

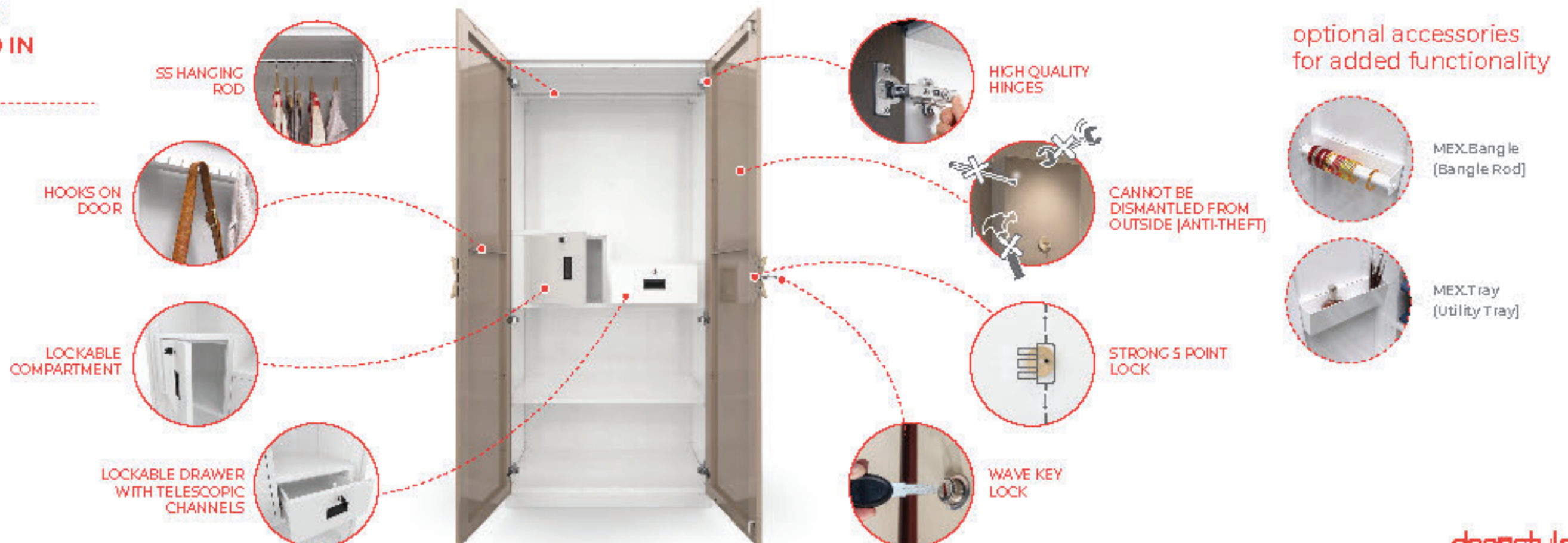

versatile
smart
made in india
chic almirah

DESIGNED & MADE by
decostyle

AVAILABLE COLORS



FEATURES INCLUDED IN ALMIRAH

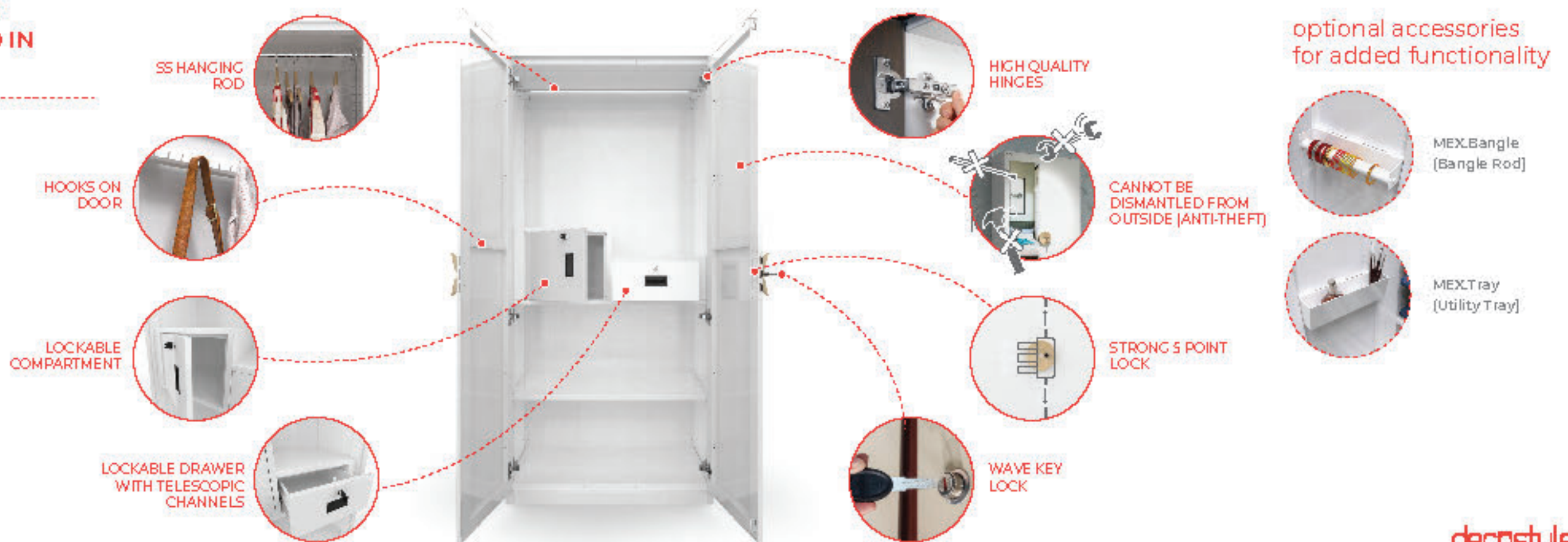

stylish
spacious
long lasting
chic almira

DESIGNED & MADE by
decostyle

AVAILABLE COLORS



FEATURES INCLUDED IN ALMIRAH

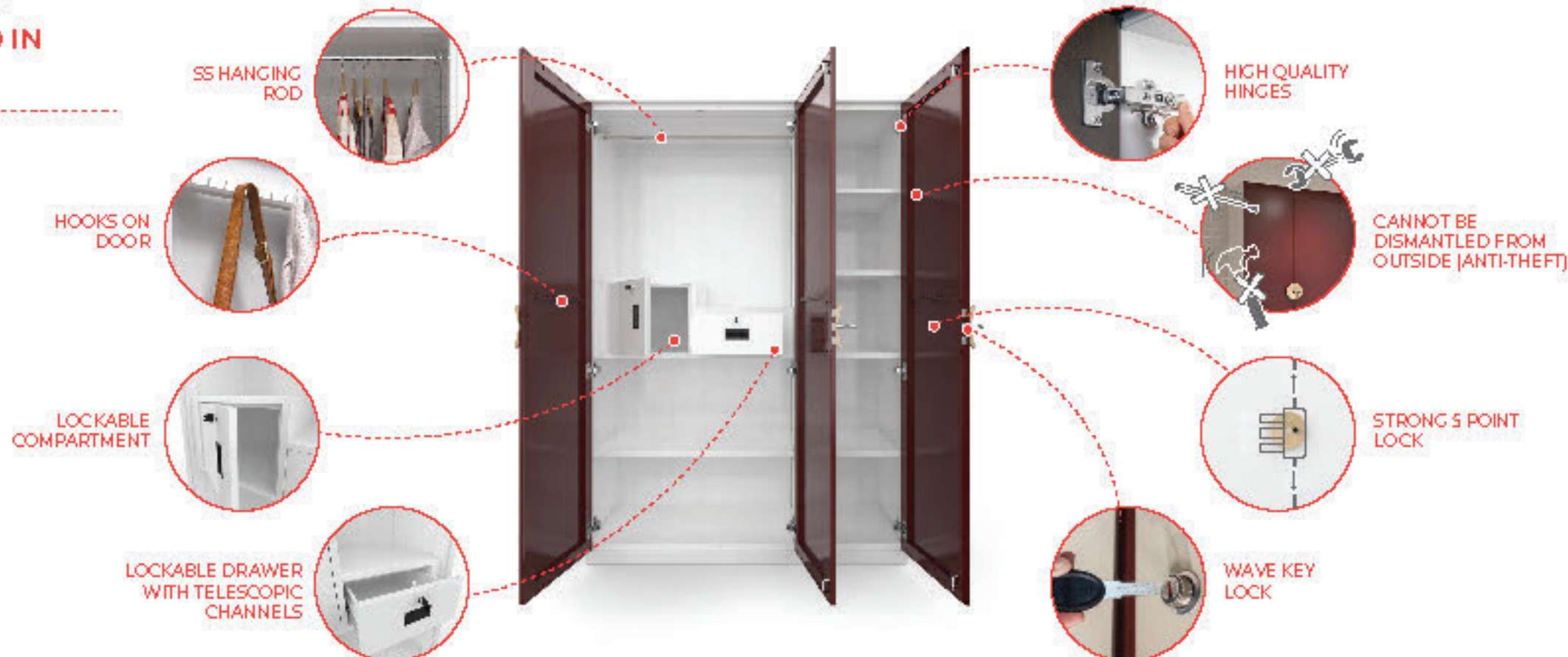

optional accessories for added functionality



designer
practical
with mirror
chic almira

DESIGNED & MADE by
decostyle



AVAILABLE COLORS



FEATURES INCLUDED IN ALMIRAH

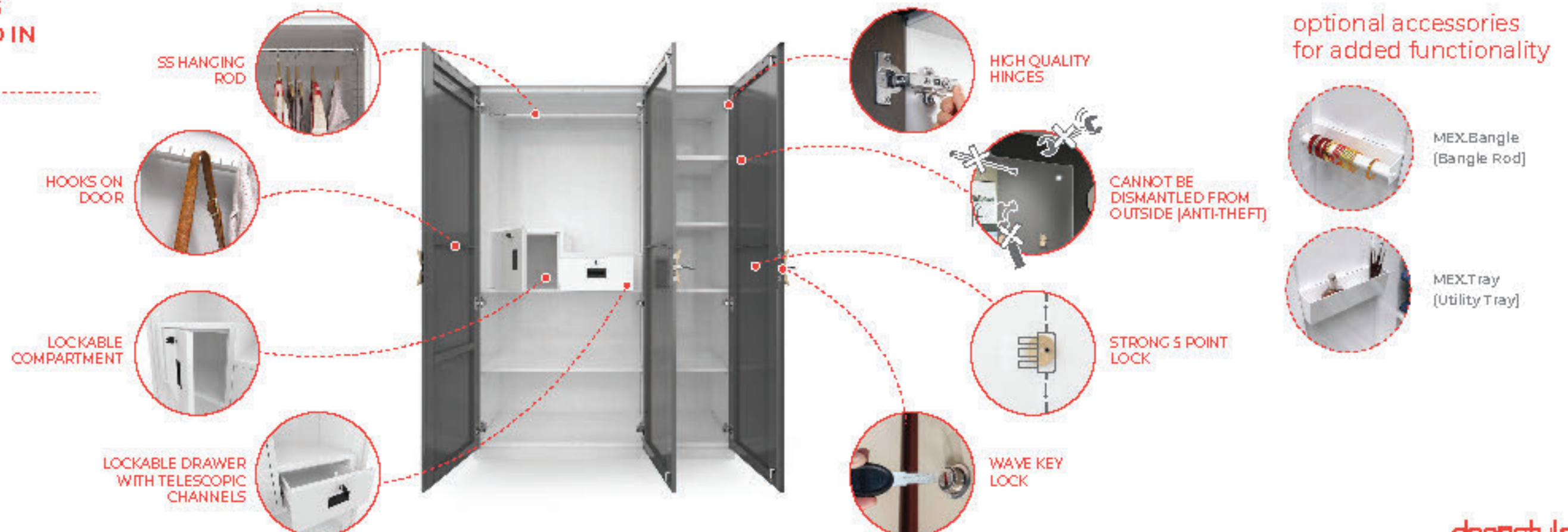

www.decostyle.co.in

decostyle



smart storage
efficient
for work

office
almirah

convenient
open
smart
metal almirah
for work



secure
stylish
sturdy
almirah



DESIGNED & MADE by
decostyle

stable
cutting edge
solid
almirah



DESIGNED & MADE by
decostyle



smart storage
efficient
for work
almirah



DESIGNED & MADE by
decostyle

match your decor

small units are available with an optional wooden top, turning it into a stylish counter top. choose a wood finish to match you interior decor



ergonomic
painstakingly
finished
almirah



"GOOD
DESIGN CON-
CENTRATES
ON THE
ESSENTIAL
ASPECTS
— Dieter Rams



DESIGNED & MADE by
decostyle

versatile
adaptable
intelligent
almirah





for every need

Our range consists of a wide variety of almirahs in different sizes and function. You can use them as partitions, display book case or a secure storage for your important documents



flexible
multi-functional
perfect
almirah



its safe!

Furniture with the strength of steel. Without giving up on precision finishes where every detail is treated delicately. To achieve this, we use cutting-edge technology.

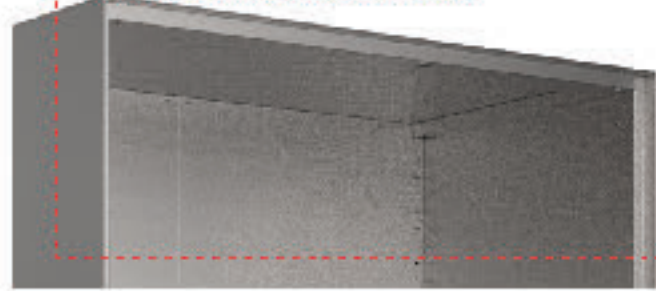

convenient adjustable shelves



strong design

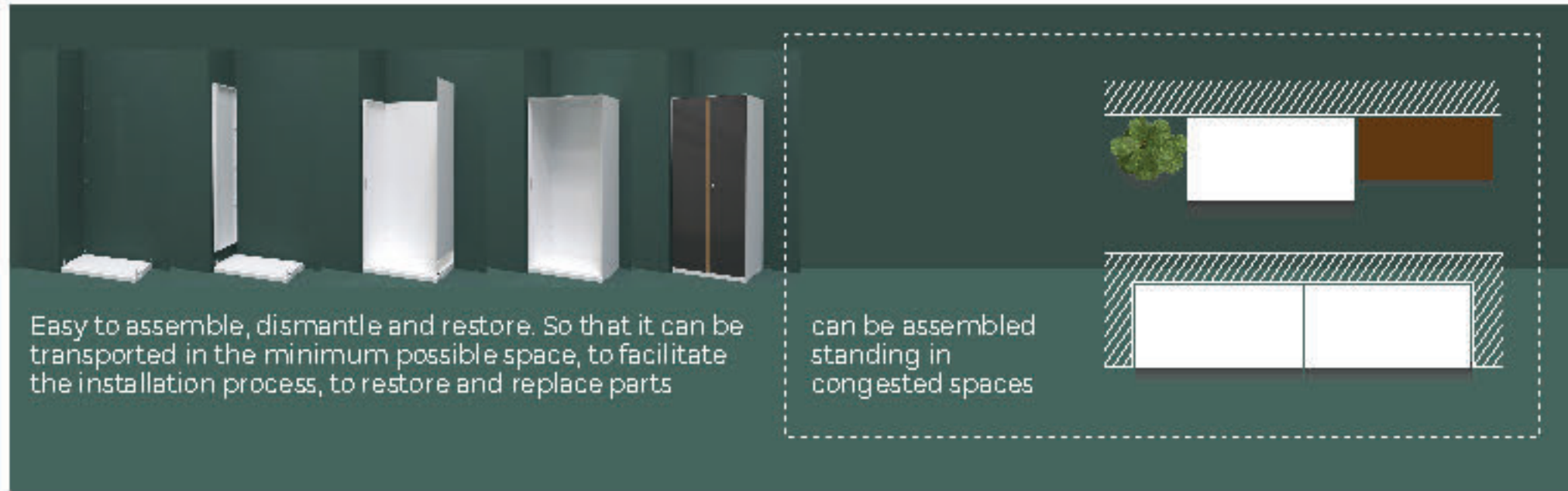
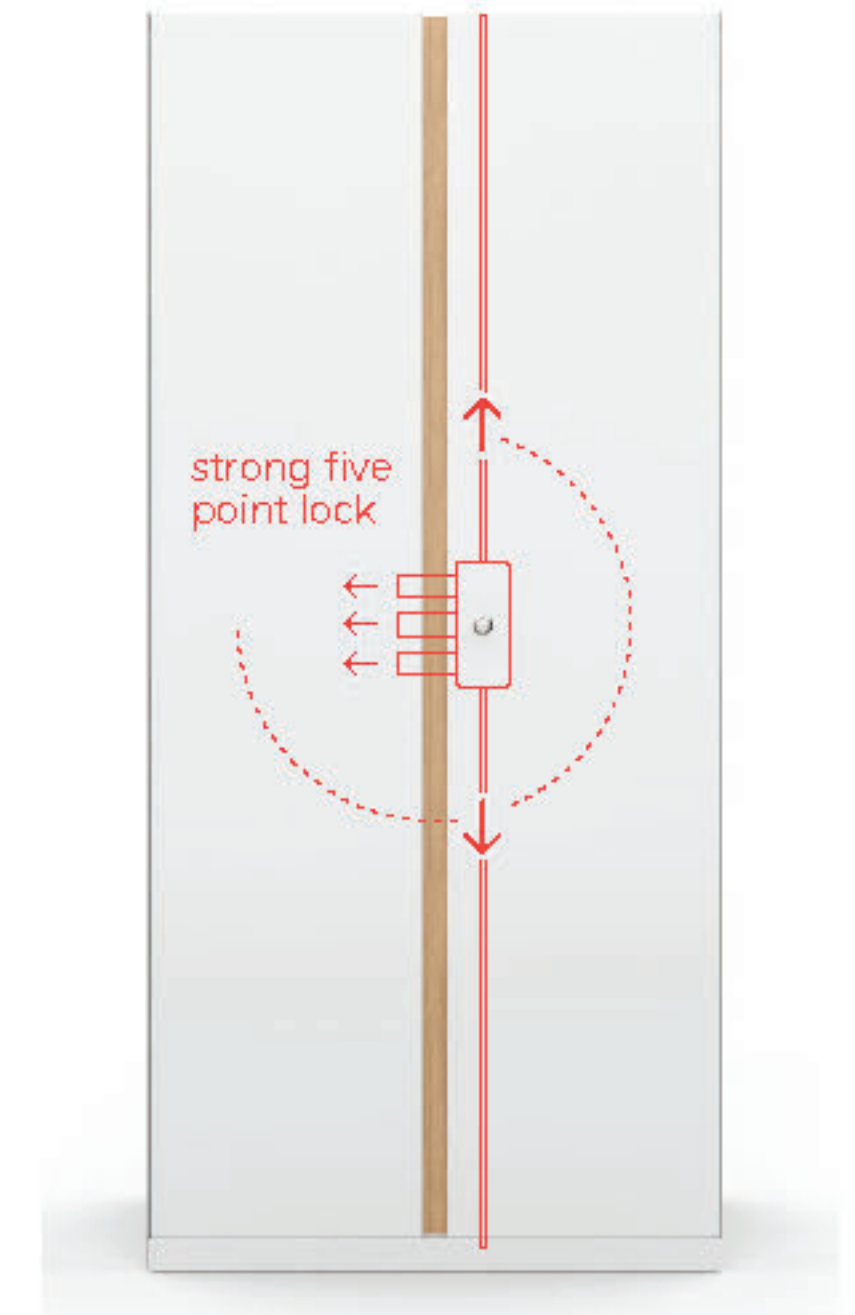

high quality hettich hinges, telescopic slides and wave keys



OFFICE ALMIRAH

 INTERIOR SHELVING OPTIONS



DIMENSIONS

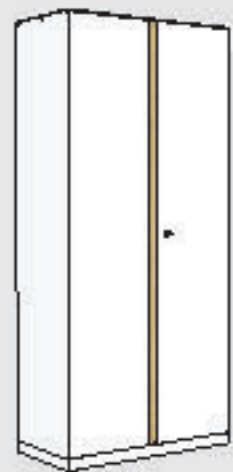

2 DOOR OFFICE ALMIRAH
 HEIGHT 197cm
 WIDTH 90cm
 DEPTH 46cm



2 DOOR OFFICE ALMIRAH
 (GLASS DOOR)
 HEIGHT 197cm
 WIDTH 90cm
 DEPTH 45cm



4 DOOR OFFICE ALMIRAH
 (GLASS DOORS)
 HEIGHT 197cm
 WIDTH 90cm
 DEPTH 46cm

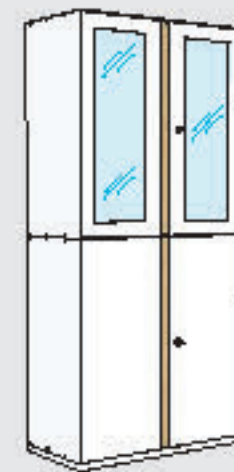

4 DOOR OFFICE ALMIRAH
 (HALF GLASS HALF METAL)
 HEIGHT 197cm
 WIDTH 90cm
 DEPTH 46cm



SMALL ALMIRAH
 HEIGHT 101cm
 WIDTH 90cm
 DEPTH 46cm

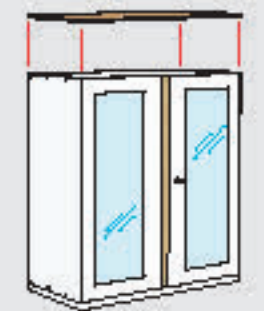

SMALL ALMIRAH (GLASS DOOR)
 HEIGHT 101cm
 WIDTH 90cm
 DEPTH 46cm

WOODEN TOP (OPTIONAL)
 HEIGHT 18cm
 WIDTH 90cm
 DEPTH 46cm

STANDARD FINISHES COMBINATIONS
FOR DOOR AND HANDLES



H1
(Standard handle shipped
with all models)

sturdy
secure
easy to maintain
chic almirah



AVAILABLE DESIGNS



FEATURES INCLUDED IN ALMIRAH

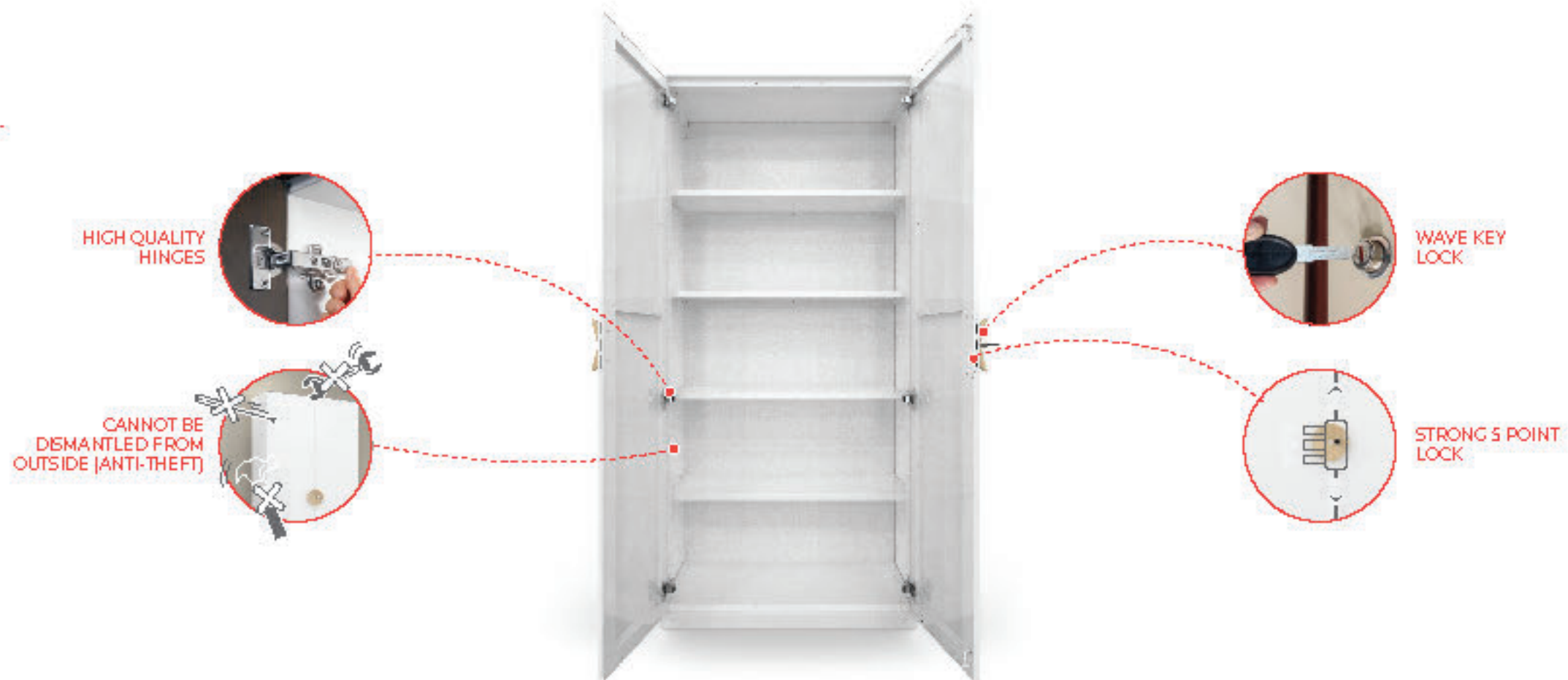



sturdy
secure
easy to maintain
chic almirah



AVAILABLE DESIGNS



FEATURES INCLUDED IN ALMIRAH



www.decostyle.co.in

decostyle



space saving
sturdy
convenient

shoeCab & shoeBench

EXPLORE

space saving
sturdy
convenient
shoeCab

DESIGNED & MADE by
decostyle

**AVAILABLE
COLORS**



SHOPPING LIST
D6C_3D_PWT_RPG_shoeCab x1



SHOPPING LIST
D6C_3D_BET_DRG_shoeCab x1



SHOPPING LIST
D6C_3D_WIT_BUT_shoeCab x1

can be combined with
the SHOEBENCH
in matching colors



**SPECIAL
HIGHLIGHTS OF
SHOECAB**



STORE UP TO 12 PAIRS OF
SLIPPERS AND SHOES



STURDY METAL
CONSTRUCTION

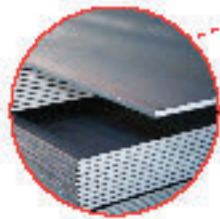

SPACE FOR SHOE POLISH
AND OTHER ITEMS



EASY TO
MAINTAIN



DIRT DOES NOT
ACCUMULATE



VENTILATION HOLES
TO PREVENT BAD SMELL

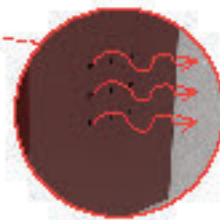

easy to maintain
compact
spacious
shoeCab

DESIGNED & MADE by
decostyle

AVAILABLE COLORS



SHOPPING LIST
D9C_4D_PWT_RPG_shoeCab x1



SHOPPING LIST
D9C_4D_BET_DRG_shoeCab x1



SHOPPING LIST
D9C_4D_WIT_BLT_shoeCab x1

can be combined with
the SHOEBENCH
in matching colors



SPECIAL HIGHLIGHTS OF SHOECAB



STORE UP TO 16 PAIRS OF
SLIPPERS AND SHOES



STURDY METAL
CONSTRUCTION

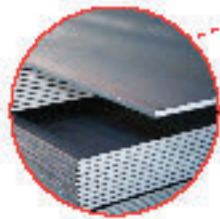

SPACE FOR SHOE POLISH
AND OTHER ITEMS



EASY TO
MAINTAIN



DIRT DOES NOT
ACCUMULATE



VENTILATION HOLES
TO PREVENT BAD SMELL



ergonomic
compact
convenient
shoeBench

**AVAILABLE
COLORS**

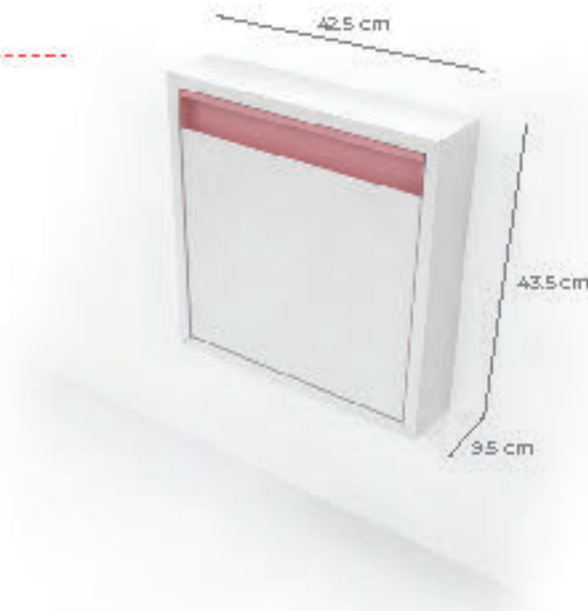

SHOPPING LIST
D9C_BI_PWT_RPG_ShoeBench x1



SHOPPING LIST
D9C_BI_BET_ORG_ShoeBench x1



SHOPPING LIST
D9C_BI_WIT_BUT_ShoeBench x1

**SPECIAL
HIGHLIGHTS OF
SHOEBENCH**



can be combined with the SHOECAB in matching colors





**DESIGNED,
ENGINEERED AND
MANUFACTURED IN
INDIA**

**100% MADE IN
INDIA WITH INDIAN
MATERIALS MATCHING
WITH GLOBAL
STANDARDS**

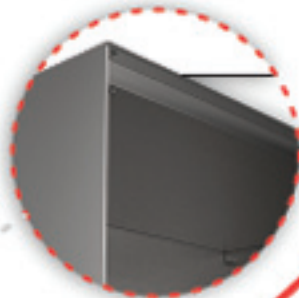

**WE HAVE VERY CAREFULLY
SELECTED HARDWARE AND
MATERIALS THAT ARE MADE IN
INDIA AND THAT MATCH
GLOBAL QUALITY STANDARDS,
THIS ALSO REDUCES THE
CARBON FOOTPRINT OF THE
PRODUCT**

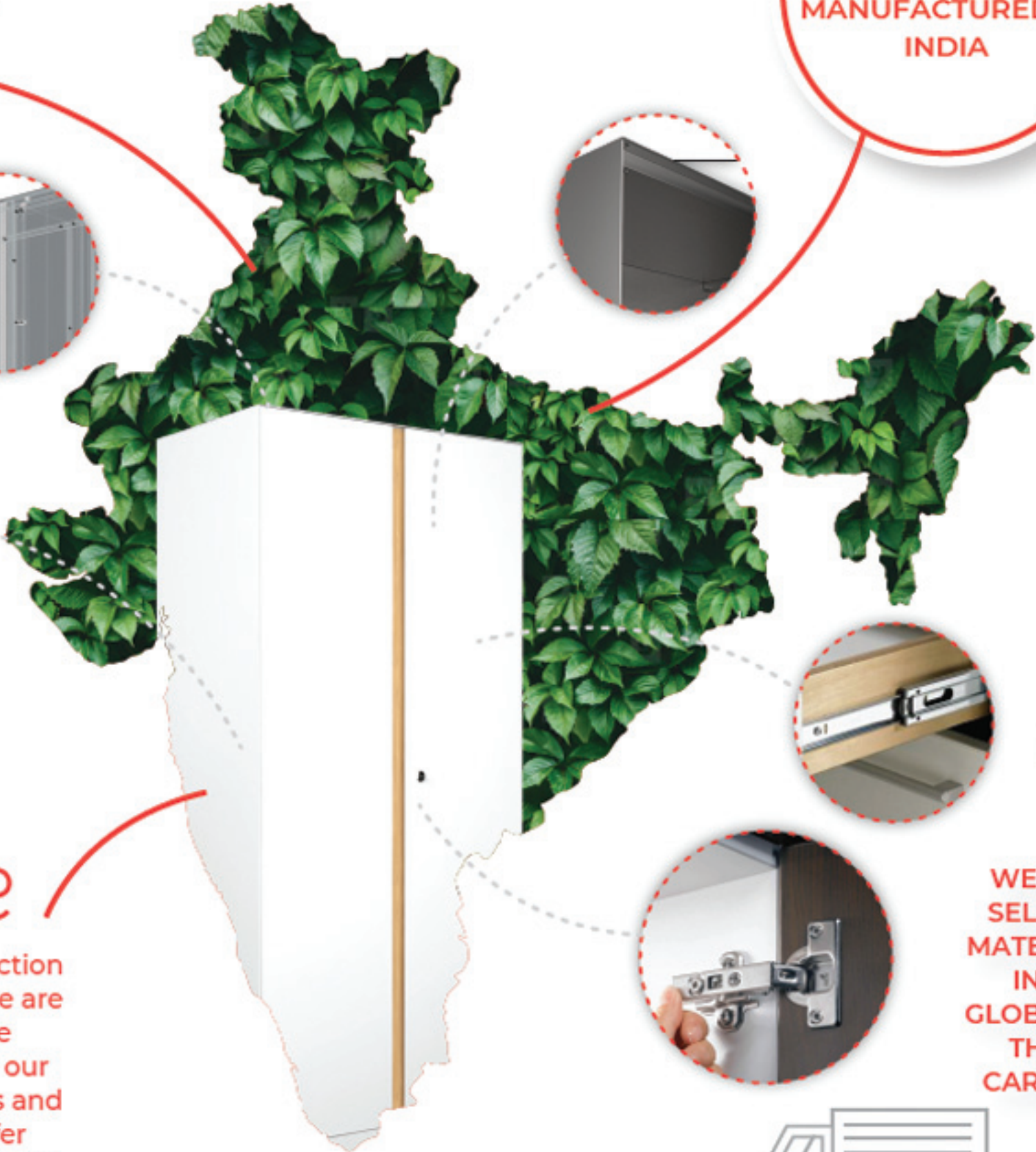

decostyle

We carry out the whole production process at our Indore plant. We are in complete command. We optimise every step. This and our major investment in machines and installations allows us to offer competitive prices without giving up on design and quality.

Growth, progress, improvements...
what does the future hold? We live in uncertain times. That's why we create products designed on the basis of adaptability. Our furniture is easy to use today and able to satisfy the needs of tomorrow. Products made from steel, solid and strong; long-lasting products.

Convenient and open. We design furniture that can satisfy all your needs, compatible with your home environments and helping to construct workspaces that modern companies need: more flexible and comfortable, richer and multifunctional.

Ergonomic and painstakingly finished
So that a strong material is also easy to use, with precise shapes and smooth to touch.

deco style

Stable and Solid
Furniture with the strength of steel. Without giving up on precision finishes where every detail is treated delicately. To achieve this, we use cutting-edge technology.

Easy to assemble, dismantle and restore. So that it can be transported in the minimum possible space. So as to facilitate the on-site installation process without causing too much fuss. To restore and replace parts in case of accident. So that it can be easily altered in the likely case of the needs of your home or company or environment changing as well.

welcome to sustainable metal production, a new production process.
where sturdiness and stability combine with optimum design and perfect functionality.
where the raw materials are treated with an eye to the future.
because we manufacture steel products while saving as many natural resources as possible.

explore



more



range

www.decostyle.co.in